

CIASC - Organograma

Estrutura Superior

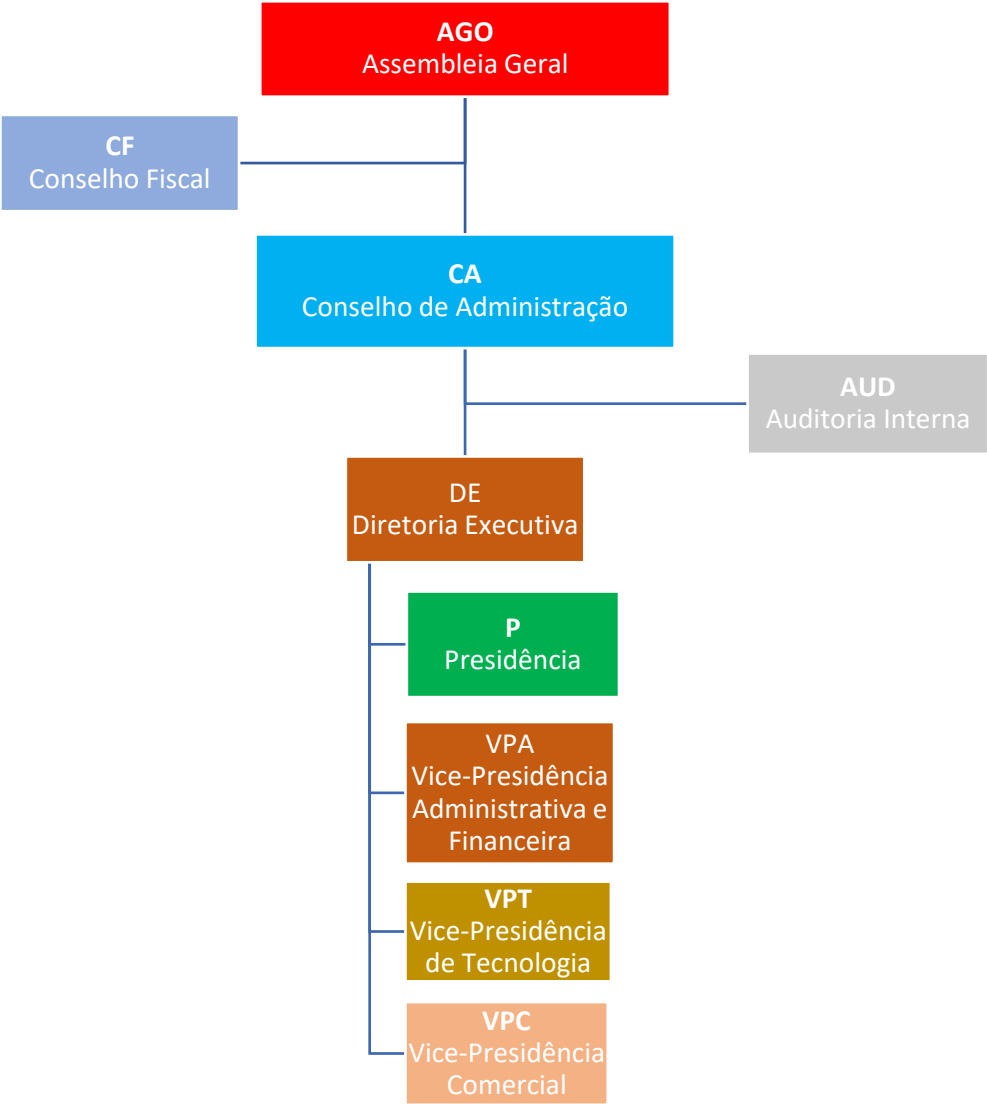

Presidência– P

Estrutura completa de Assessorias

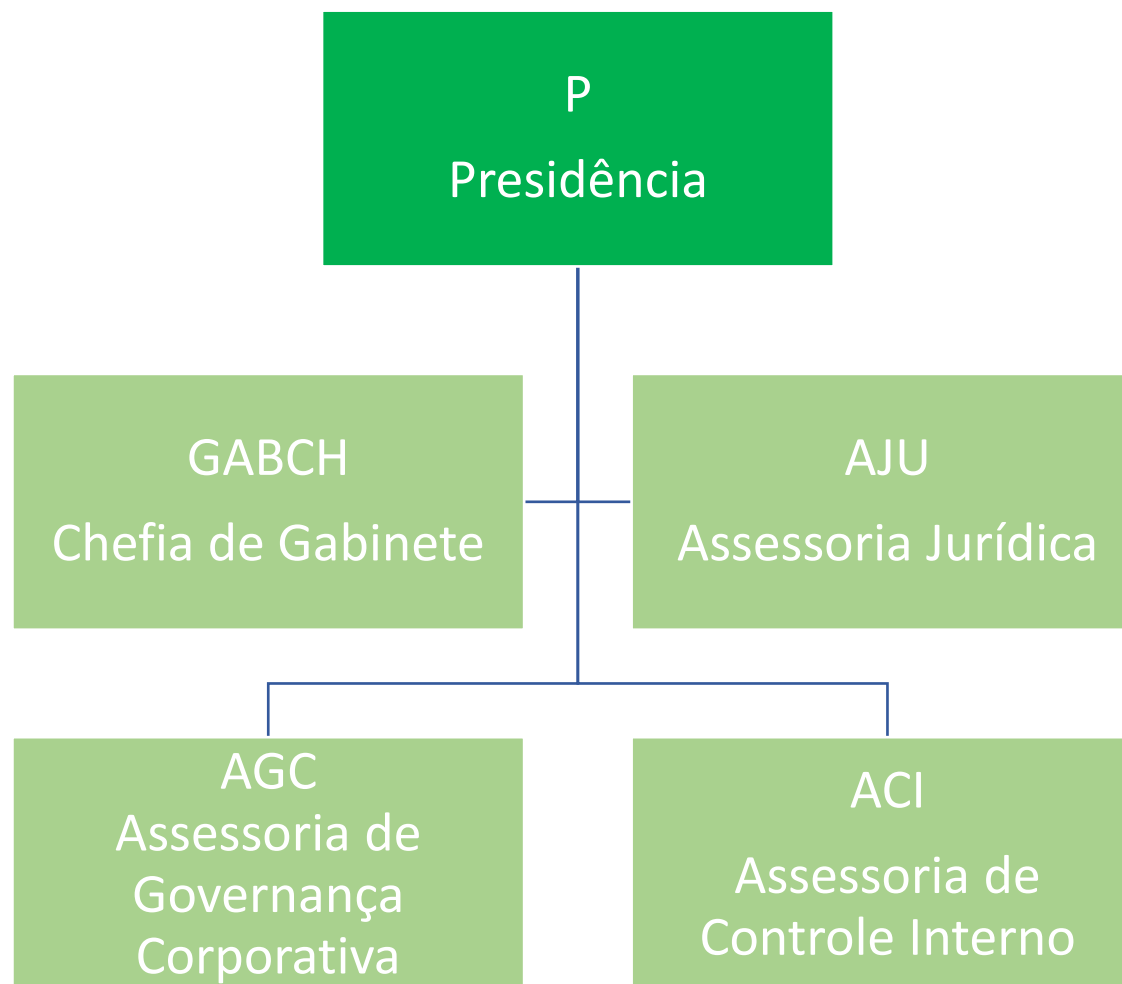

Vice-presidência Administrativa e Financeira – VPA

Estrutura completa de Gerências e Coordenadorias

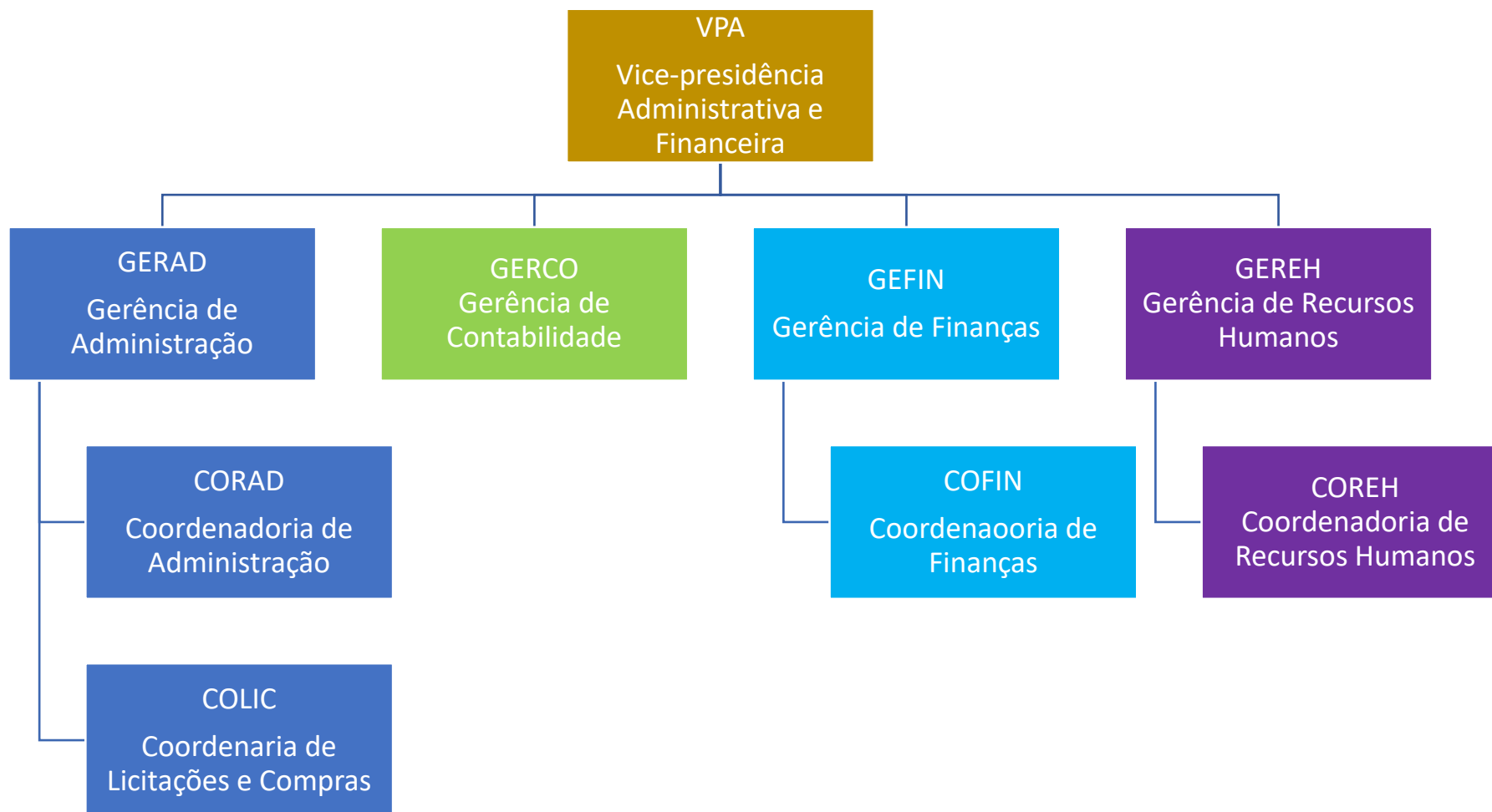

Vice-presidência de Tecnologia – VPT

Estrutura de Gerências e Coordenadorias

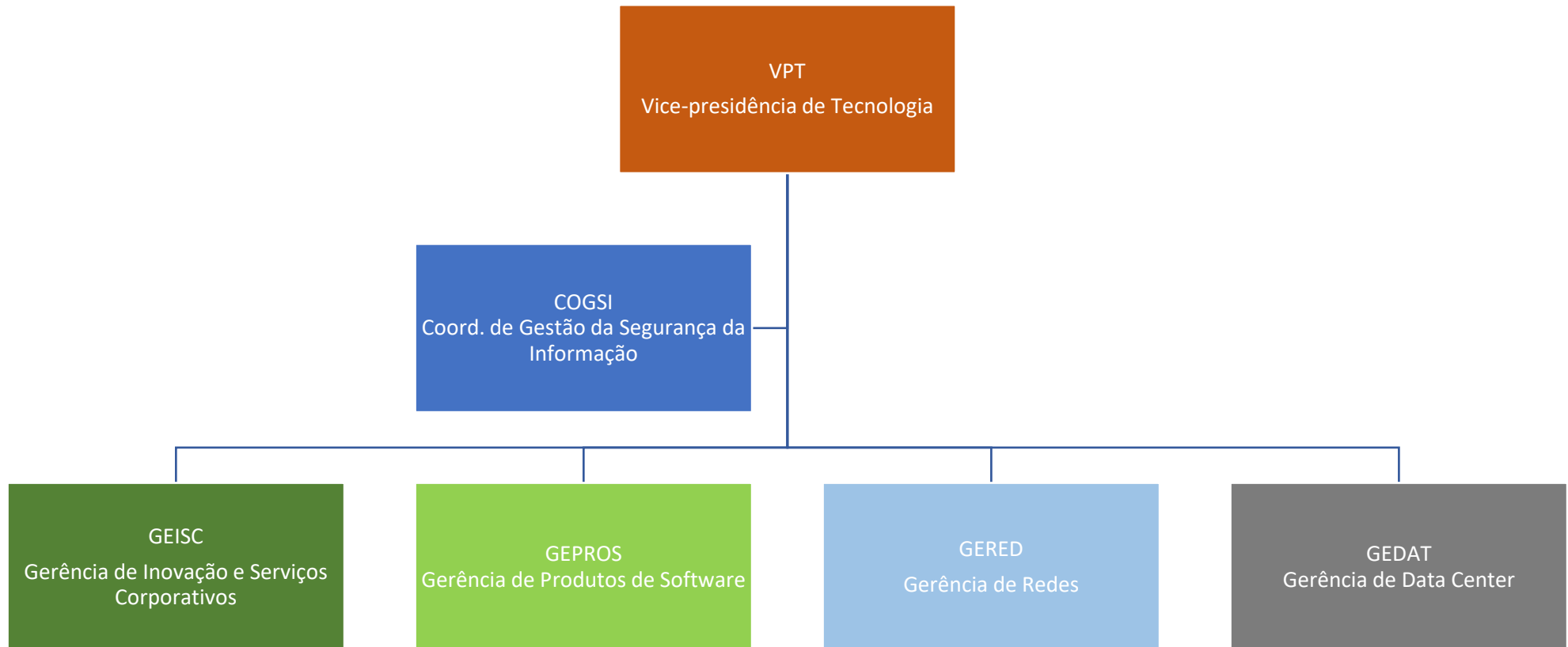

VPT

Estrutura da Gerência de Inovação e Serviços Corporativos - GEISC

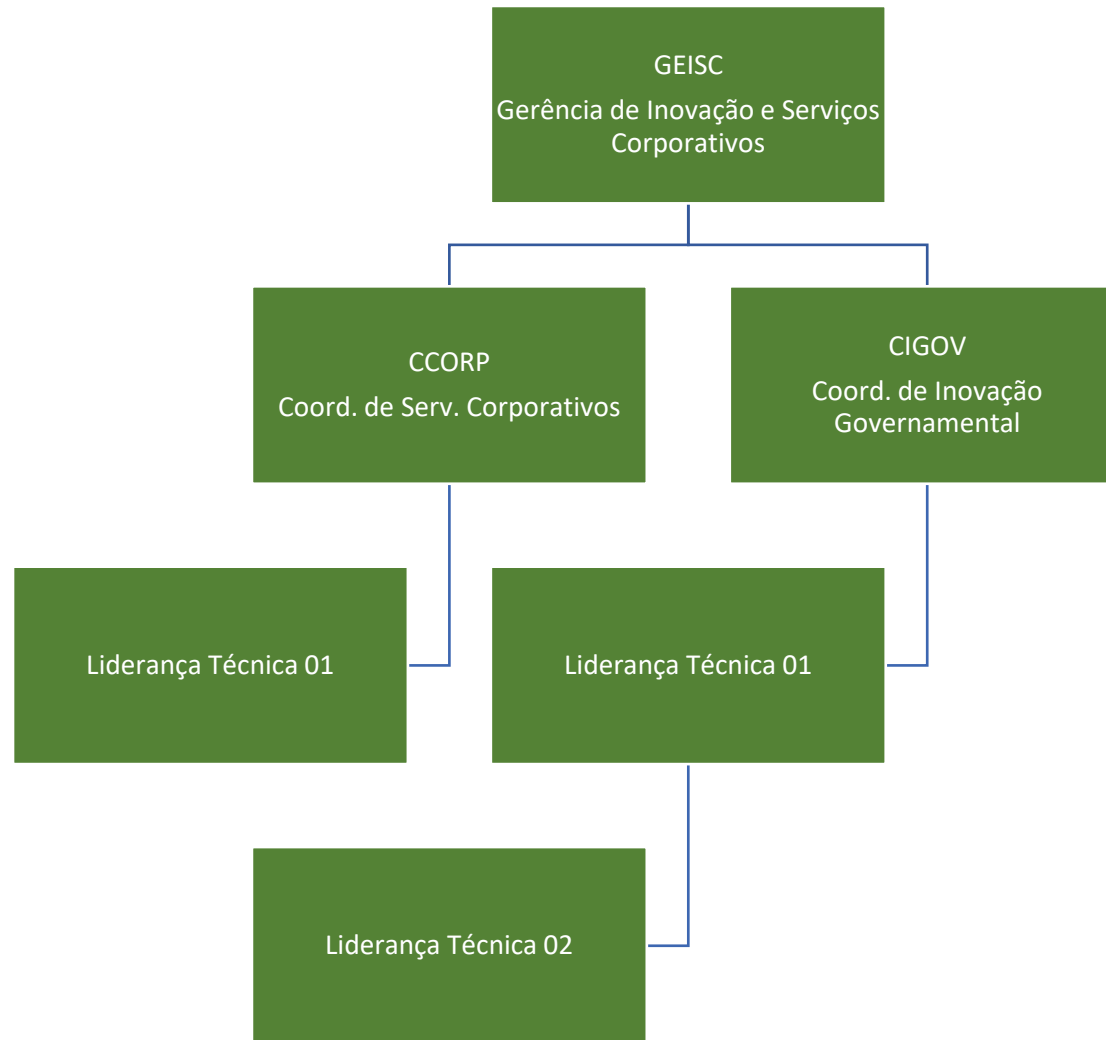

Estrutura da Gerência de Produtos de Software - GPROS

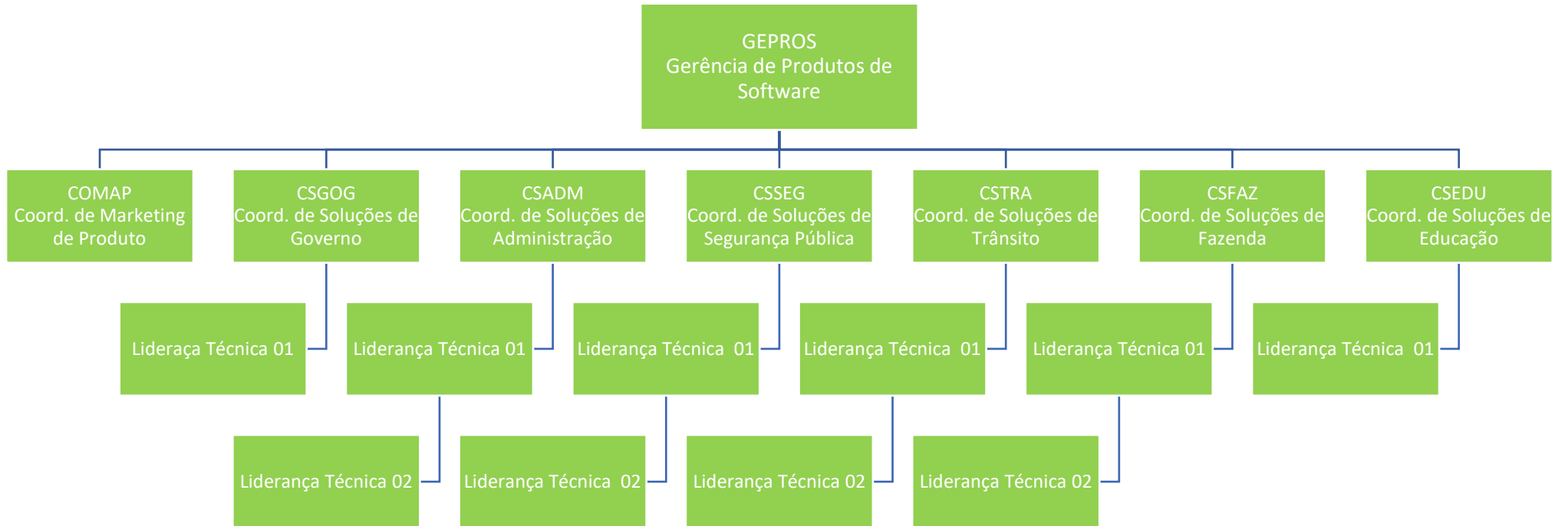

VPT
Estrutura da Gerência de Redes - GERED

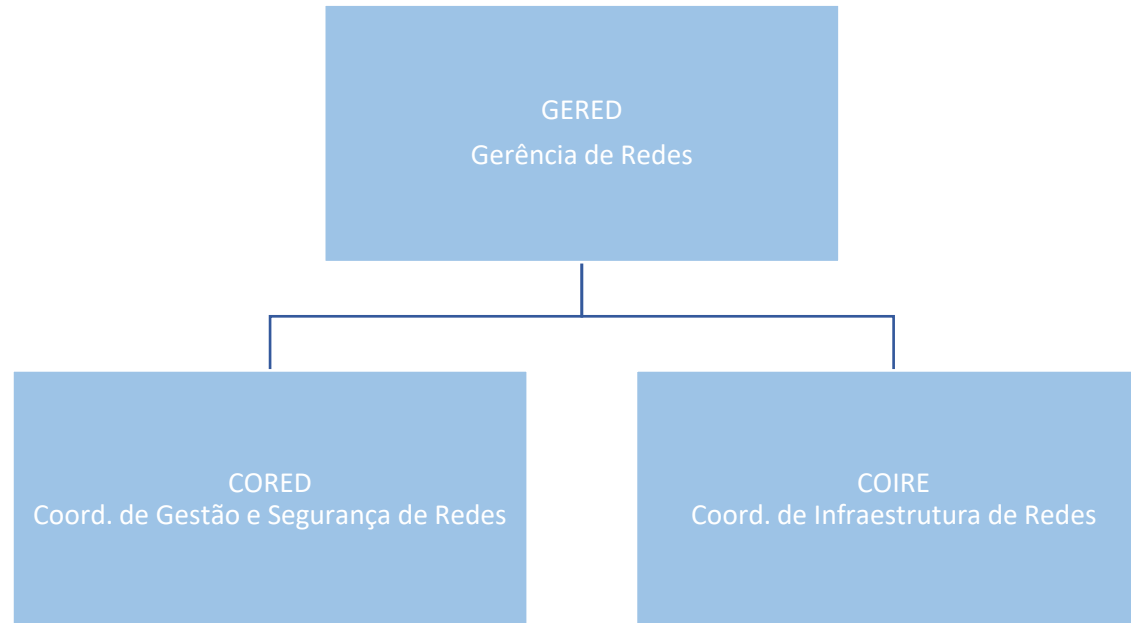

VPT
Estrutura da Gerência de Data Center - GEDAT

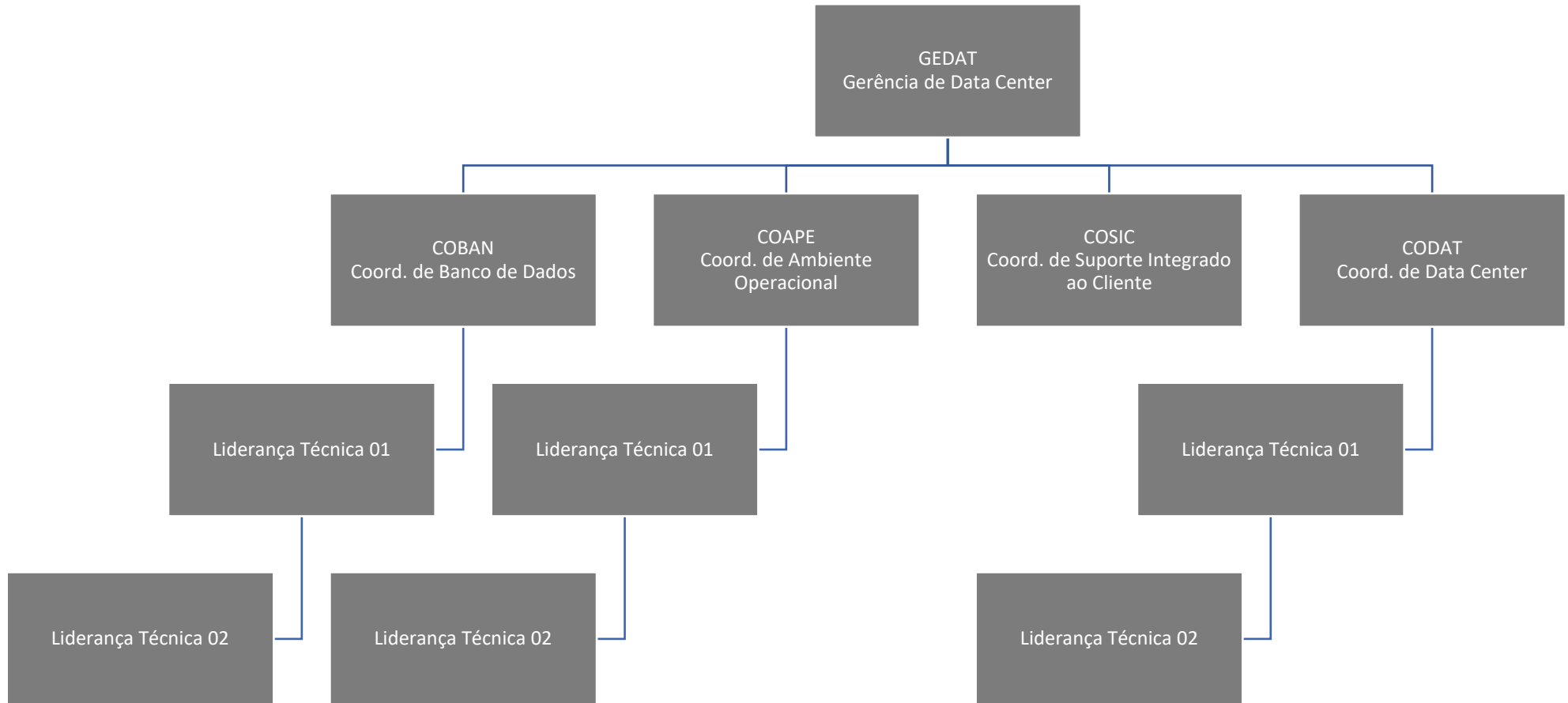

Vice-presidência Comercial– VPC

Estrutura completa de Gerência e Coordenadorias

